

# Electricity and Multimeters

This appendix gives you a general introduction to what electricity is and how it is measured. In addition, you will learn to use a multimeter to measure the voltage output of a power supply.

---

## Electricity: A Basic Introduction

To most people, volts, ohms, watts, and amps are vague words that have to do with electricity. If these terms are mysterious to you, they will become clear in this section, which discusses electricity in nontechnical language and uses simple analogies.

Electricity is energy and water is matter, but the two have enough in common to make some comparisons. Consider Figure E-1. The water system shown in the top part of the figure is closed— that is, the amount of water in the system remains the same because no water enters and no water leaves the system. The electrical system in the lower part of the figure is similar in several respects. Think of electricity as a stream of tiny charged particles (electrons) that flow like water along the path of least resistance.

Just as water flows down because of the force of gravity, electricity flows from negative to positive because of the force of like charges repelling one another. The water pump produces water pressure in the system by lifting the water, and a battery produces electrical pressure in the system by creating a buildup of negative charges (in the form of electrons) in one location, which are driven to move. This difference in charge, which is similar to water pressure in a water system, is called potential difference. Water seeks a place of rest, moving from a high to a low elevation, and electrons seek a place of rest by moving from a negatively charged location (sometimes called “hot”) to a positively charged location (sometimes called “ground”). In the figure, as water flows through the closed system, the water wheel harnesses some of its force and converts it to a form of energy, motion. Also in the figure, as the electrons flow in the closed electrical system called a circuit, the light bulb harnesses some of the force of the moving electrons and converts it to another form of energy, light. When the water returns to the pool, water pressure decreases and the water is at rest. When the electrons arrive at the positive side of the battery, electrical potential difference decreases, and the system is at rest.

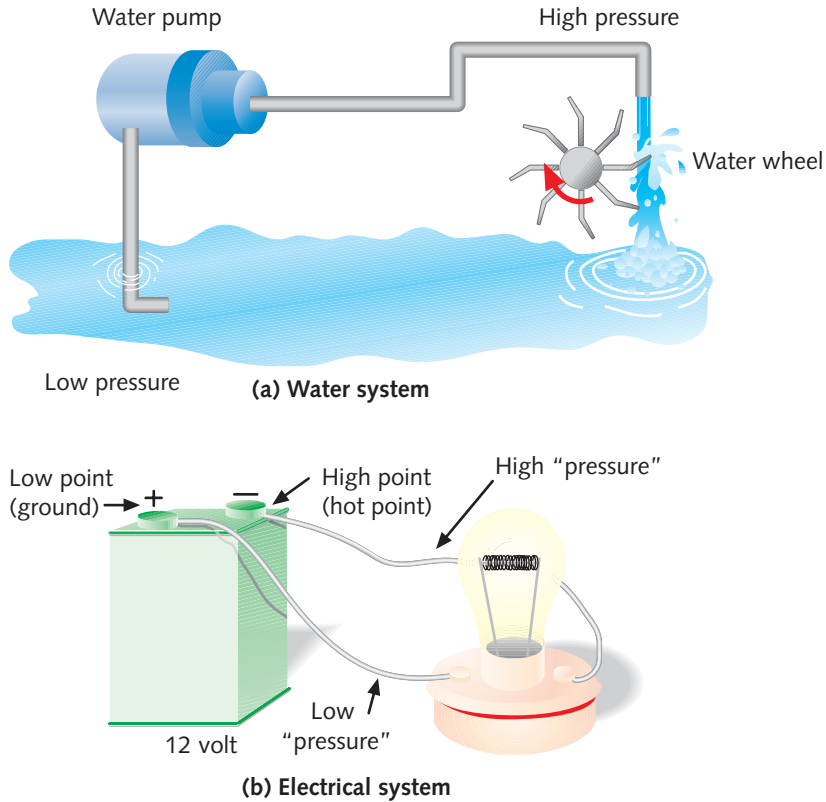

**Figure E-1** Two closed systems: (a) water system with pump, wheel, and pool; (b) electrical system with battery and light bulb



**NOTE**

Electron flow goes from the hot point, or negative terminal, to the ground, or positive terminal. Because early theories of electricity assumed that electricity flowed from positive to negative, most electronics books show the current flowing from positive to negative. This theory is called conventional current flow; if it were used in Figure E-1, the figure would show reversed positive and negative symbols.

Electrical energy has properties that you can measure in various ways. Table E-1 defines four properties of electricity, how they can be measured, and some examples of each. These properties are explained in detail in the following sections.

Unit	Definition	Computer Example
Volt (measures potential difference)	Abbreviated as V (for example, 110 V). Volts are measured by finding the potential difference between the electrical charges on either side of an electrical device in an electrical system.	An AT power supply provides four separate voltages: +12 V, -12 V, +5 V, and -5 V. An ATX power supply provides these voltages and +3.3 V as well.
Amp or ampere (measures electrical current)	Abbreviated as A (for example, 1.5 A). Amps are measured by placing an ammeter in the flow of current and measuring that current.	A 17-inch monitor requires less than 2 A to operate. A small laser printer uses about 2 A. A CD-ROM drive uses about 1 A.
Ohm (measures resistance)	Abbreviated with the symbol $\Omega$ (for example, 20 $\Omega$ ). Devices are rated according to how much resistance to electrical current they offer. The ohm rating of a resistor or other electrical device is often written somewhere on the device. The resistance of a device is measured when the device is not connected to an electrical system.	Current can flow in typical computer cables and wires with a resistance of near zero $\Omega$ .
Watt (measures power)	Abbreviated W (for example, 20 W). Watts are calculated by multiplying volts by amps.	A computer power supply is rated at 200 to 600 W.

**Table E-1** Measures of electricity

## Voltage

The first measure of electricity listed in Table E-1 is potential difference. First, consider how to measure the water pressure in Figure E-1. If you measure the pressure of the water directly above the water wheel and then measure the pressure just as the water lands in the pool, you find that the water pressure above the wheel is greater than the water pressure below it.

Now consider the electrical system. If you measure the electrical charge on one side of the light bulb and compare it with the electrical charge on the other side of the bulb, you see a difference in charge. The potential difference in charge creates an electrical force called **voltage**, which drives the electrons through the system between two points. Voltage is measured in units called **volts (V)**.

In Figure E-2, the leads of a **voltmeter**, a device for measuring electrical voltage, are placed on either side of a light bulb that consumes some electrical power. The potential difference between the two points on either side of the device is the voltage in the closed system. Voltage is measured when the power is on.

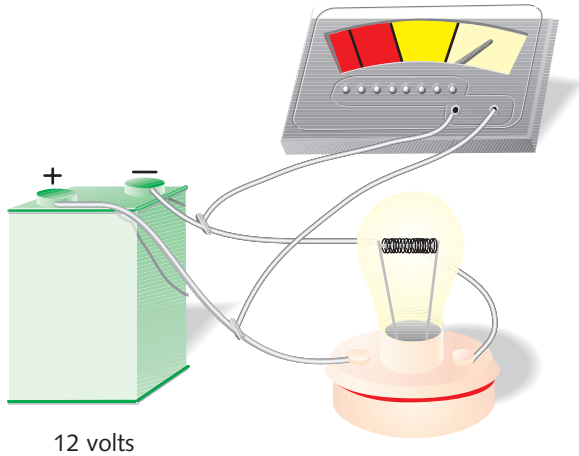

**Figure E-2** A voltmeter measuring the voltage across a bulb and a battery

## Amps

The volume of electrons (or electricity) flowing through an electrical system is called current. Look back at Figure E-1. The volume or amount of water flowing through the water system does not change, although the water pressure changes at different points in the system. To measure that volume, you pick one point in the system and measure the volume of water passing through that point over a period of time. The electrical system is similar. If you measure the number of electrons, or electrical current, at any point in this system, you find the same value as at any other point, because the current is constant throughout the system. (This assumes that the entire closed water or electrical system has only a single pipe or a single wire.) Electrical current is measured in **amperes (A)**, abbreviated **amps**. Figure E-3 shows an **ammeter**, a device that measures electrical current in amps. You place the ammeter in the path of the electrical flow so that the electrons must flow through the ammeter. The measurement, which you take with the power on, might not be completely accurate because the ammeter can influence the circuit.

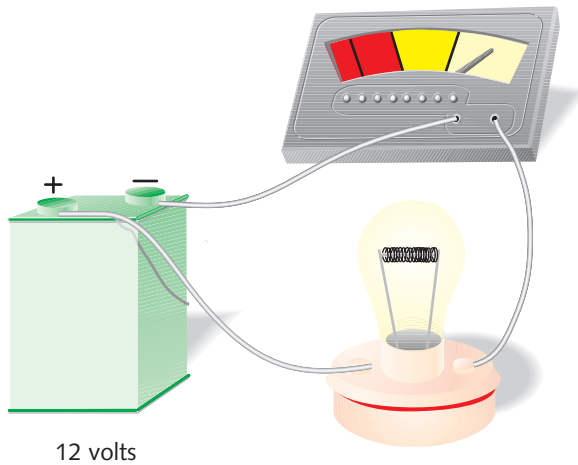

**Figure E-3** Battery and bulb circuit with ammeter in line



Because the current flows through an ammeter, check the rating of the ammeter before measuring amps to make sure it can handle the flow of electricity. More flow than the ammeter is designed to handle can blow the meter's fuse.

## Relationship Between Voltage and Current

Refer again to the water system in Figure E-1. To increase the volume of water flowing through the system, you increase the difference in water pressure between the low and high points (which is called the pressure differential). As the pressure differential increases, the water flow (or current) increases, and as the water pressure differential decreases, the water flow (or current) decreases. Another way of saying this is: There is a direct relationship between pressure differential and current. An electrical system works the same way. As the electrical potential difference (or voltage) increases, the electrical current increases; as the voltage decreases, the current decreases. There is a direct relationship between voltage and current.

## Ohms

Suppose you are working your water pump to full capacity. If you still want to increase the overall power of your water system—so the wheel turns faster to produce more mechanical energy—you could decrease the resistance to water flow, allowing more water to flow to push the wheel faster. You might use a larger pipe or a lighter water wheel, or, if the system has a partially open water valve, you could open the valve more; these alternatives all would lower resistance to water flow. As resistance

decreases, current increases. As resistance increases (smaller pipes, heavier wheel, partially closed valve), current decreases.

Similarly, **resistance** in an electrical system is a property that opposes the flow of electricity. As electrical resistance increases, the flow of electrons decreases. As resistance decreases, the electricity increases. (A condition of low resistance that allows current to flow in a completed circuit is called **continuity**). When too much electricity flows through a wire, it creates heat energy (similar to friction) in the wire. This heat energy can cause the wire to melt or burn, which can result in an electrical fire, just as too much water current can cause a pipe to burst. Reducing the size of a wire reduces the amount of electricity that can safely flow through it. Electrical resistance is measured in **ohms ( $\Omega$ )**.

**Resistors** are devices used in electrical circuits to resist the flow of electricity. These devices control the flow of electricity in a circuit, much as partially closed valves control the flow of water.

## Relationships of Resistance to Current and Voltage

Voltage and current have a direct relationship. This means that when voltage increases, current increases. Resistance has an inverse relationship with current and a direct relationship with voltage. This means that as resistance increases, current decreases if voltage remains constant, such as when you use a dimmer switch to dim a light. As a general rule, the more voltage you expect in an electrical system, in order for current to remain constant, the more resistance you must add in the form of a larger-capacity resistor. This last statement is known as Ohm's Law. A similar statement defines the relationship among the units of measure: volts, amps, and ohms. One volt drives a current of one amp through a resistance of one ohm.

## Wattage

**Wattage** is the total amount of power needed to operate an electrical device. When thinking of the water system, you recognize that the amount of water power used to turn the water wheel is not just a measure of the water pressure that forces current through the system. The amount of power also depends on the amount of water available to flow. For a given water pressure, you have more power with more water flow and less power with less water flow. A lot of power results when you have a lot of pressure and a lot of current.

As with the water system, electrical power increases as both voltage and current increase. Wattage, measured in **watts (W)**, is calculated by multiplying volts by amps in a system ( $W = V \times A$ ). For example, 120 volts times 5 amps is 600 watts. Note that while volts and amps are measured to determine their value, watts are calculated from those values.

We now turn our attention to how to use a multimeter to measure voltage output of a computer's power supply.

## Measure the Voltage of a Power Supply

If you suspect a problem with a power supply, the simplest and preferred solution is to replace it with a new one. However, in some situations, you might want to measure the voltage output. When a power supply works properly, voltages all fall within an acceptable range (plus or minus 10 percent). However, be aware that even if measured voltage falls within the appropriate range, a power supply can still cause problems. This is because problems with power supplies are intermittent—in other words, they come and go. Therefore, if the voltages are correct, you should still suspect the power supply is the problem when certain symptoms are present. To learn for certain whether the power supply is the problem, replace it with a unit you know is good.

E

### Using a Multimeter

A voltmeter measures the difference in electrical potential between two points, in volts, and an ammeter measures electrical current in amps. Figure E-4 shows a multimeter, which can be used as either a voltmeter or an ammeter or can measure resistance or continuity (the presence of a complete circuit with no resistance to current), depending on a dial or function switch setting.

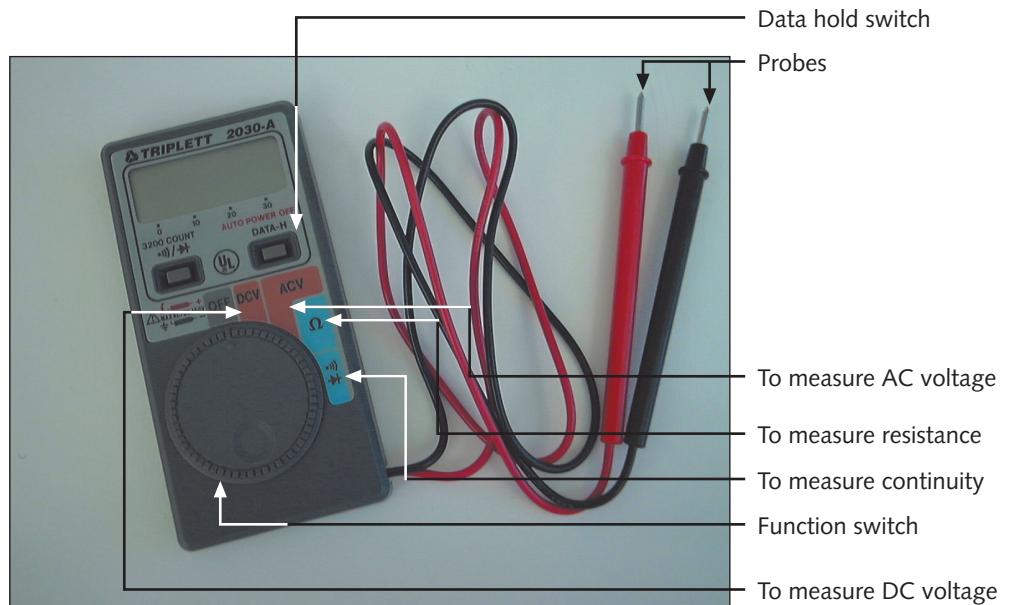

Figure E-4

A digital multimeter

Less expensive multimeters commonly measure voltage, resistance, and continuity, but not amps. Measure voltage and amps while the electricity is on. Measure resistance and continuity while the electricity is off. For the specific details of how to use your multimeter, consult the manual, which explains what you can measure with the multimeter and how to use it.

Multimeters are sometimes small, portable, battery-powered units. Larger ones are designed to sit on a countertop and are powered by a wall outlet. A multimeter can provide either a digital or an analog display. A digital display shows the readings as digits on an LCD (liquid crystal display) panel. A digital multimeter is sometimes called a DMM (digital multimeter) or a DVM (digital voltage meter). An analog display shows the readings as a needle moving across a scale of values.

Before you begin to use a multimeter, you must tell it three things: (1) what you want it to measure (voltage, current, or resistance), (2) whether the current is AC or DC, and (3) what range of values it should expect. If you are measuring the voltage output from a wall outlet (110–120 V), the range should be much higher than when you are measuring the voltage output of a computer power supply (3–12 V). Setting the range high assures you that the meter can handle a large input without pegging the needle (exceeding the highest value the meter is designed to measure) or damaging the meter. However, if you set the range too high, you might not see the voltage register at all. Set the range low enough to ensure that the measure is as accurate as you need but not lower than the expected voltage. When you set the range too low on some digital multimeters, the meter reads OL on the display.

For example, to measure the voltage of house current, if you expect the voltage to be 115 volts, set the voltage range from 0 to somewhere between 120 and 130 volts. You want the high end of the range to be slightly higher than the expected voltage. To protect themselves, most meters do not allow a very large voltage or current into the meter when the range is set low. Some multimeters are autorange meters, which sense the quantity of input and set the range accordingly.

A meter comes with two test probes. One is usually red and the other black. Install the red probe at the positive (+) jack on the meter and the black probe at the negative (-) jack.

## How to Measure Voltage

To measure voltage, place the other end of the black probe at the ground point and the other end of the red probe at the hot point, without disconnecting anything in the circuit and with the power on. For example, to measure voltage using the multimeter in Figure E-4, turn the function switch dial to DCV for DC voltage measurement. This meter is autoranging, so that's all that needs to be set. With the power on, place the two probes in position and read the voltage from the LCD panel. The DATA-H (data hold) switch allows you to freeze the displayed reading.





When using a multimeter to measure voltage, current, or resistance, be careful not to touch a chip with the probes.

## How to Measure Current

In most troubleshooting situations, you will measure voltage, not current. However, you should know how to measure current. To measure current in amps, the multimeter itself must be part of the circuit. Disconnect the circuit at some point so that you can connect the multimeter in line to find a measure in amps. Not all multimeters can measure amps.

## How to Measure Continuity

You can also use a multimeter to measure continuity. If there is little or no resistance (less than 20 ohms gives continuity in a PC) in a wire or a closed connection between two points, the path for electricity between the two points is unhindered or “continuous.” This measurement is taken with no electricity present in the circuit.

For example, if you want to know that pin 2 on one end of a serial cable is connected to pin 3 on the other end of the cable, set the multimeter to measure continuity, and work without connecting the cable to anything. Put one probe on pin 2 at one end of the cable and the other probe on pin 3 at the other end. If the two pins connect, the multimeter shows a reading on the LCD panel, or a buzzer sounds (see the multimeter documentation). In this situation, you might find that the probe is too large to extend into the pinhole of the female connection of the cable. A straightened small paper clip works well here to extend the probe. However, be very careful not to use a paper clip that is too thick and might widen the size of the pinhole, because this can later prevent the pinhole from making a good connection.

One way to determine if a fuse is good is to measure continuity. Set a multimeter to measure continuity, and place its probes on each end of the fuse. If the fuse has continuity, then it is good. If the multimeter has no continuity setting, set it to measure resistance. If the reading in ohms is approximately zero, there is no resistance and the fuse is good. If the reading is infinity, resistance is infinite; the fuse is blown and should not be used.

## How to Measure the Voltage of a Power Supply

To determine whether a power supply is working properly, measure the voltage of each circuit the power supply supports. First, open the computer case and identify all power cords coming from the power supply. Look for the cords from the power supply to the motherboard and other power cords to the drives (see Figure E-5).

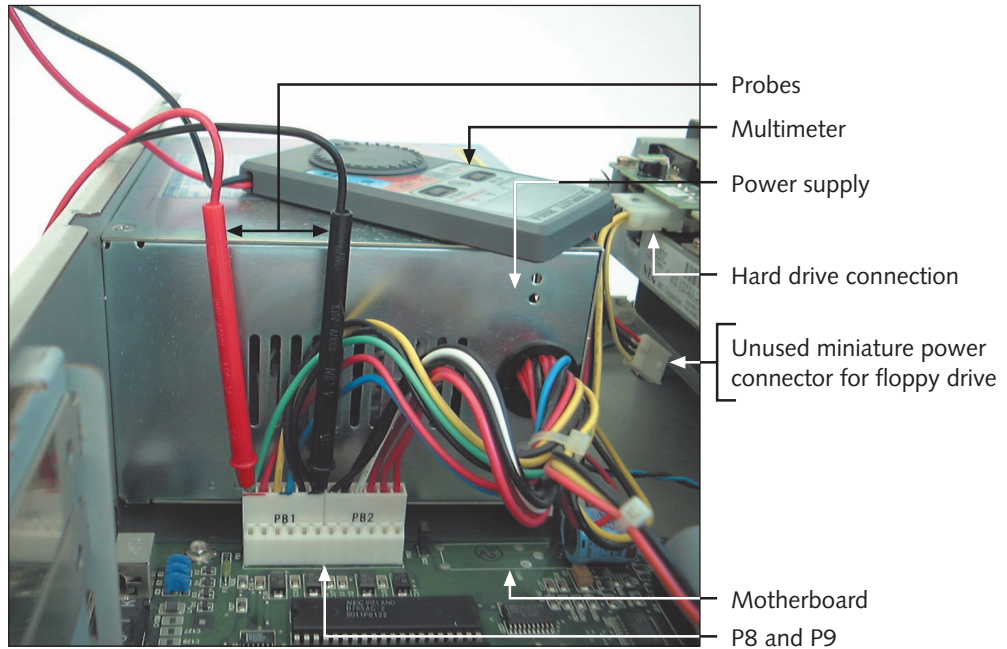

**Figure E-5**

Multimeter measuring voltage on an AT motherboard

The computer must be turned on to test the power supply output. Be very careful not to touch any chips or disturb any circuit boards as you work. The voltage output from the power supply is no more than 14 volts, not enough to seriously hurt you if you accidentally touch a hot probe. However, you can damage the computer if you are not careful.

You can hurt yourself if you accidentally create a short circuit from the power supply to ground through the probe. If you touch the probe to the hot circuit and to ground, you divert current from the computer circuit and through the probe to ground. This short might be enough to cause a spark or to melt the probe, which can happen if you allow the two probes to touch while one of them is attached to the hot circuit and the other is attached to ground. Make sure the probes only touch one metal object, preferably only a single power pin on a connector, or you could cause a short.

Because of the danger of touching a hot probe to a ground probe, you might prefer not to put the black probe into a ground lead too close to the hot probe. Instead, when the directions say to place the black probe on a lead very close to the hot probe, you can use a black wire lead on an unused power supply connection meant for a hard drive. The idea is that the black probe should always be placed on a ground or black lead.

All ground leads are considered at ground, no matter what number they are assigned. Therefore, you can consider all black leads to be equal. For an AT motherboard, the ground leads for P8 and P9 are the four black center leads 5, 6, 7, and 8. For an ATX motherboard, the ground leads are seven black leads in center positions

on the ATX P1 power connector. The ground leads for a hard drive power connection are the two black center leads, 2 and 3.

The following sections first discuss how to measure the power output for AT and ATX motherboards and then discuss the procedure for a secondary storage device.

## Measuring Voltage Output to an AT Motherboard

1. Remove the cover of the computer. The voltage range for each connection is often written on the top of the power supply. The two power connections to the motherboard are often labeled P8 and P9. Figure E-6 shows a close-up of the two connections, P8 and P9, coming from the power supply to the motherboard. Each connection has six leads, for a total of 12 leads. Of these 12, four are ground connections and lead 1 is a “power good” pin, used to indicate that the motherboard is receiving power. Table E-2 lists the purposes of these 12 leads.

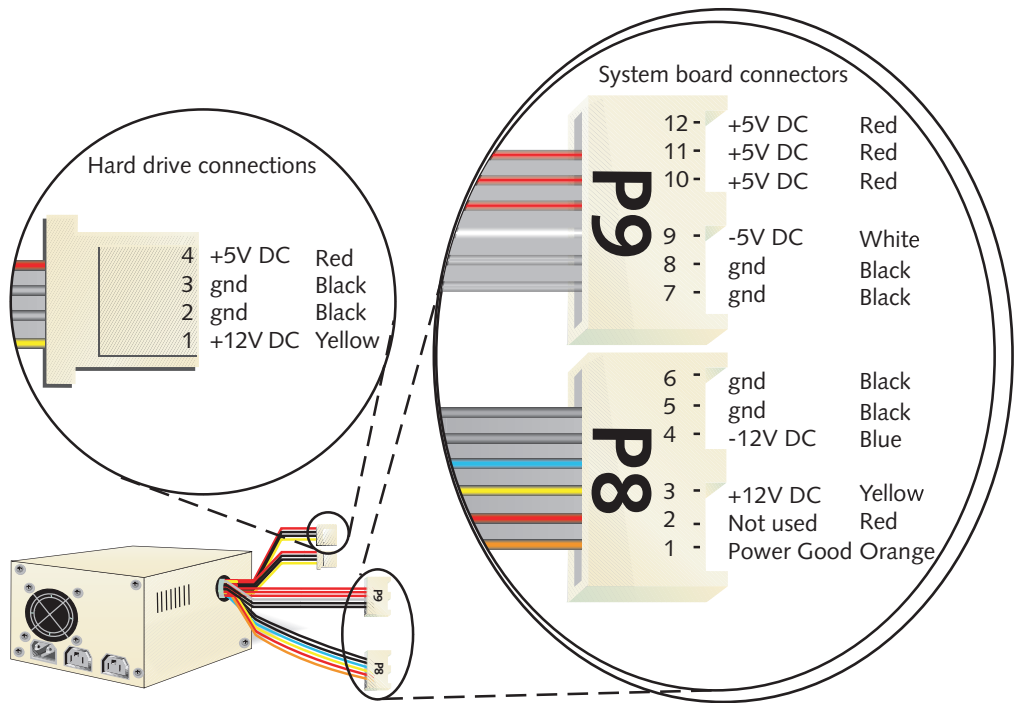

Figure E-6

AT power supply connections

Connection	Lead	Description	Acceptable Range
P8	1	"Power Good"	
	2	Not used or +5 volts	+4.4 to +5.2 volts
	3	+12 volts	+10.8 to +13.2 volts
	4	-12 volts	-10.8 to -13.2 volts
	5	Black ground	
	6	Black ground	
P9	7	Black ground	
	8	Black ground	
	9	-5 volts	-4.5 to -5.5 volts
	10	+5 volts	+4.5 to +5.5 volts
	11	+5 volts	+4.5 to +5.5 volts
	12	+5 volts	+4.5 to +5.5 volts

**Table E-2** Twelve leads to the AT motherboard from the AT power supply

2. Set the multimeter to measure voltage in a range of 20 volts, and set the AC/DC switch to DC. Insert the black probe into the negative (-) jack and the red probe into the positive (+) jack of the meter.



Be certain the multimeter is set to measure voltage and not current (amps). If the multimeter is set to measure current, you might damage the power supply or motherboard or both.

3. Turn on the multimeter and turn on the computer.
4. To measure the +12-volt circuit and all four ground leads:
  - a. Place the red probe on lead 3. The probe is shaped like a needle. (Alligator clips don't work too well here.) Insert the needle down into the lead housing as far as you can. Place the black probe on lead 5. The acceptable range is +10.8 to +13.2 volts.
  - b. Place the red probe on lead 3, and place the black probe on lead 6. The acceptable range is +10.8 to +13.2 volts.

- c. Place the red probe on lead 3, and place the black probe on lead 7. The acceptable range is +10.8 to +13.2 volts.
  - d. Place the red probe on lead 3, and place the black probe on lead 8. The acceptable range is +10.8 to +13.2 volts.
5. To measure the -12-volt circuit, place the red probe on lead 4, and place the black probe on any ground lead or on the computer case, which is also grounded. The acceptable range is -10.8 to -13.2 volts.
  6. To measure the -5-volt circuit, place the red probe on lead 9, and place the black probe on any ground. The acceptable range is -4.5 to -5.5 volts.
  7. To measure the three +5-volt circuits:
    - a. Place the red probe on lead 10, and place the black probe on any ground. The acceptable range is +4.5 to +5.5 volts.
    - b. Place the red probe on lead 11, and place the black probe on any ground. The acceptable range is +4.5 to +5.5 volts.
    - c. Place the red probe on lead 12, and place the black probe on any ground. The acceptable range is +4.5 to +5.5 volts.
  8. Turn off the PC and replace the cover.

### Measuring Voltage Output to an ATX Motherboard

To measure the output to the ATX motherboard, follow the procedure just described for the AT motherboard. Recall that the ATX board uses 3.3, 5, and 12 volts coming from the power supply. Figure E-7 shows the power output of each pin on the connector. Looking at Figure E-7, you can see the distinguishing shape of each side of the connector. Notice the different hole shapes (square or rounded) on each side of the connector, ensuring that the plug from the power supply is oriented correctly in the connector. Also notice the notch on the connector and on the pinout diagram on the right side of the figure. This notch helps orient you as you read the pinouts. You can also use the color of the wires coming from the power supply to each pin on the P1 connector to help orient the connector. Table E-3 lists the leads to the motherboard and their acceptable voltage ranges.

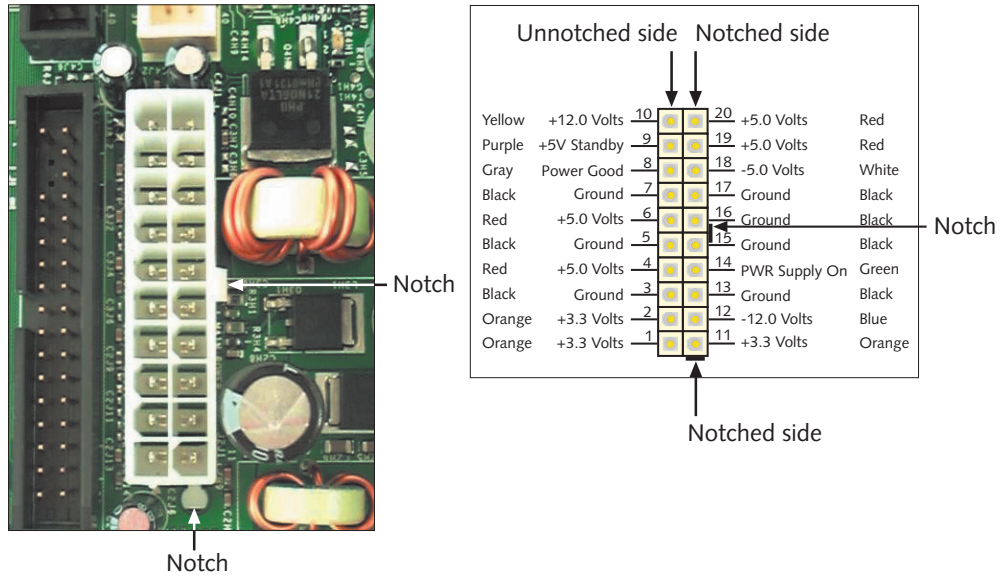

Figure E-7 Power connection on an ATX motherboard

Unnotched Side			Notched Side		
Lead	Description	Acceptable Range (Volts)	Lead	Description	Acceptable Range (Volts)
1	+3.3 volts	+3.1 to +3.5V	11	+3.3 volts	+3.1 to +3.5V
2	+3.3 volts	+3.1 to +3.5V	12	-12 volts	-10.8 to -13.2V
3	Black ground		13	Black ground	
4	+5 volts	+4.5 to +5.5V	14	Power supply on	
5	Black ground		15	Black ground	
6	+5 volts	+4.5 to +5.5V	16	Black ground	
7	Black ground		17	Black ground	
8	Power Good		18	-5 volts	-4.5 to -5.5V
9	+5 volts standby	+4.5 to +5.5V	19	+5 volts	+4.5 to +5.5V
10	+12 volts	+10.8 to +13.2V	20	+5 volts	+4.5 to +5.5V

Table E-3 Twenty leads to the ATX motherboard from the ATX power supply

**NOTE**

Dell ATX power supplies and motherboards made after 1998 might not use the standard P1 pinouts for ATX, although the power connectors look the same. For this reason, *never* use a Dell power supply with a non-Dell motherboard, or a Dell motherboard with a non-Dell power supply, without first verifying that the power connector pinouts match; otherwise, you might destroy the power supply, the motherboard, or both. End PC Noise ([www.endpcnoise.com](http://www.endpcnoise.com)) sells a pinout converter to convert the P1 connector of a Dell power supply or motherboard to standard ATX. Also, PC Power and Cooling ([www.pcpowerandcooling.com](http://www.pcpowerandcooling.com)) makes a power supply modified to work with a Dell motherboard.

**E**

## Testing the Power Output to a Floppy or Hard Drive

The power cords to the hard drive, CD-ROM drive, floppy drive, and other drives all supply the same voltage: one +5-volt circuit and one +12-volt circuit. These connectors use four leads; the two outside connections are hot, and the two inside connections are ground (see Figure E-6). The power connection to a 3.5-inch floppy disk drive is usually a miniature connection, slightly smaller than other drive connections, but still with four pins. Follow these steps to measure the voltage to any drive:

1. With the drive plugged in, turn on the computer.
2. Set the multimeter to measure voltage, as described earlier.
3. Place the red probe on lead 1, shown in the drive connection callout in Figure E-6, and place the black probe on lead 2 or 3 (ground). The acceptable range is +10.8 to +13.2 volts.
4. Place the red probe on lead 4, and place the black probe on lead 2 or 3 (ground). The acceptable range is +4.5 to +5.5 volts.

You may choose to alter the method you use to ground the black probe. In Step 4, the red probe and black probe are very close to each other. You may choose to keep them farther apart by placing the black probe in a ground lead of an unused hard drive connection.

## Practicing Measuring the Output of Your Power Supply

To practice, measure the power output to your motherboard and to the hard drive. Fill in the following charts. Note that red and black leads refer to the color of the probes.

## AT Motherboard

Red Lead	Black Lead	Voltage Measure
3	5	
3	6	
3	7	
3	8	
4	Ground	
9	Ground	
10	Ground	
11	Ground	
12	Ground	

## ATX Motherboard

Red Lead	Black Lead	Voltage Measure
10	7	
10	5	
10	3	
10	17	
10	16	
10	15	
10	13	
9	Ground	
6	Ground	
4	Ground	
2	Ground	
1	Ground	
20	Ground	
19	Ground	
18	Ground	

(continued)



Red Lead	Black Lead	Voltage Measure
12	Ground	
11	Ground	

## Hard Drive

Red Lead	Black Lead	Voltage Measure
1	3	
4	2	

